

BIG WHEELED PAVER - GENERATOR INSTALLATION

Workshop Instruction



- Publication Number** : WI-221212-3-HC-Big wheeled Paver - Generator drive installation
- Applicable to** : F2500W, F2500WS, SD2500W, SD2500WS with electrical heating (Generation 2016 or higher)
- PGC** : H100
- Responsible person** : Technical Support Department Wardenburg
(gmbh-service@dynapac.com)

4812327188
Dec-2022

Table of contents

1.	Revision History	4
1.1	Form filling instructions.....	4
2.	Subject	5
3.	Safety precautions	5
4.	General machine information	6
5.	Description	9
5.1	General overview design.....	9
5.2	Check anti vibration pads of engine suspension	10
5.3	Fastening of generator coupling.....	12
5.4	Design of cardan shaft.....	14
5.5	Bolt connection	17
5.6	Dimension of assembled generator drive	19
5.7	Software	21
6.	Application	21
7.	Reporting	21

1. Revision History

REV. :	DATE	REVISION SUMMARY	AUTHOR	CHECKED	APPROVED
00	2022-12-13	First release	Alexander Pitz		

1.1 Form filling instructions

1. Kindly fill all the Grey text fields

example:

Machine Type	Big wheeled paver
Machine serial number	

2. Select the required options & click check Boxes

example:

Surfaces of generator shaft and coupling clean

Distance washer 4812010759 installed

3. Click the image icon boxes, to attach the images as below

example:

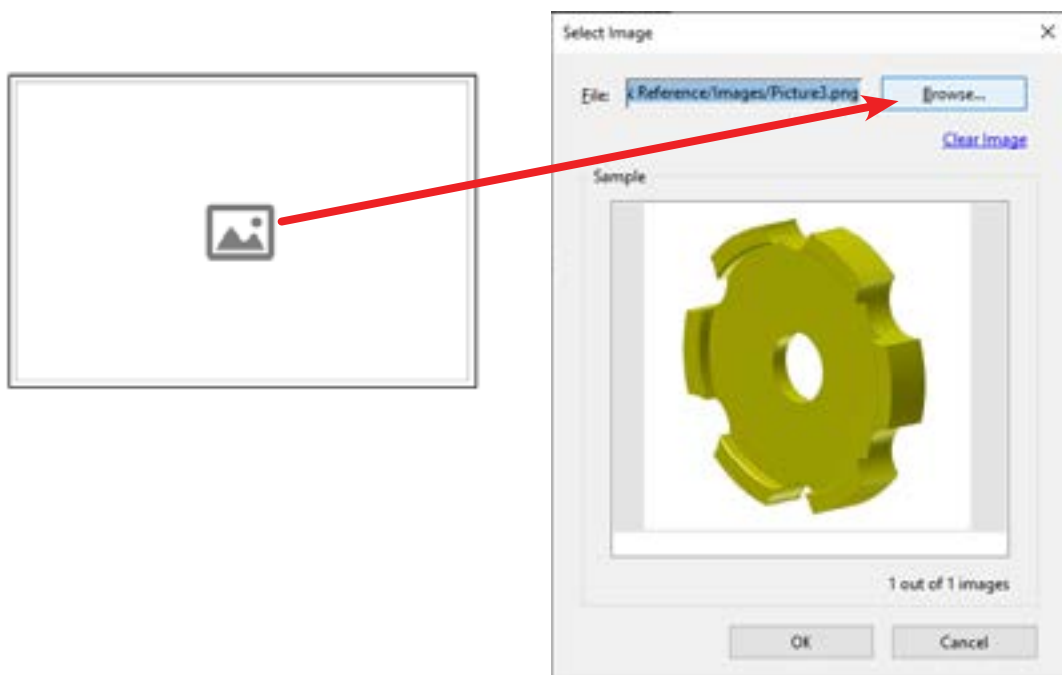

2. Subject

Big wheeled Paver - Generator installation

3. Safety precautions

- The operator must employ safe working practices and observe all related local work safety requirements and regulations, also the technical documentation (such as operators manual and safety instructions) has to be followed.
- Maintenance must only be performed by authorised, trained and specialised personnel.
- Before maintenance, repair work, adjustment or any other non-routine checks, stop the equipment, switch off the main battery switch.
- Use only the correct tools for maintenance and repair work.
- A warning sign bearing a legend such as 'Work in progress; do not start' shall be attached to the starting equipment.
- Scrupulously observe cleanliness during maintenance and repair. Keep dirt away by covering the parts and exposed openings with a clean cloth, paper or tape.
- Make sure that no tools, loose parts or rags are left in or on the machine.
- All regulating and safety devices shall be maintained with due care to ensure that they function properly. They may not be put out of action.
- Always wear the following personal protective equipment: Work clothing, safety shoes, safety goggles, ear protection and safety gloves when there is a cutting risk or a risk for a heat injury.

4. General machine information

Points	Information to fill
Machine Type	
Machine serial number	
Actual operating hour	
Master software version	
Display software version	
Old	
Generator type	
Generator part number	
Generator serial number	
New	
Generator type (new)	
Generator part number (new)	
Generator serial number (new)	
Technician name	
Date of repair	

Picture to be added below:

General machine overview picture

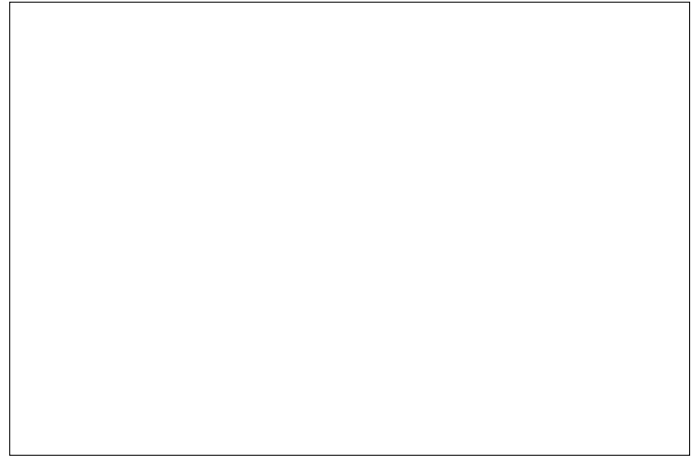
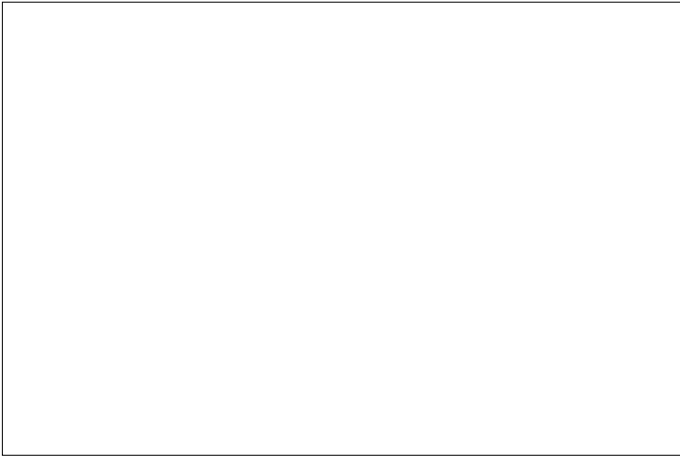

Machine type plate

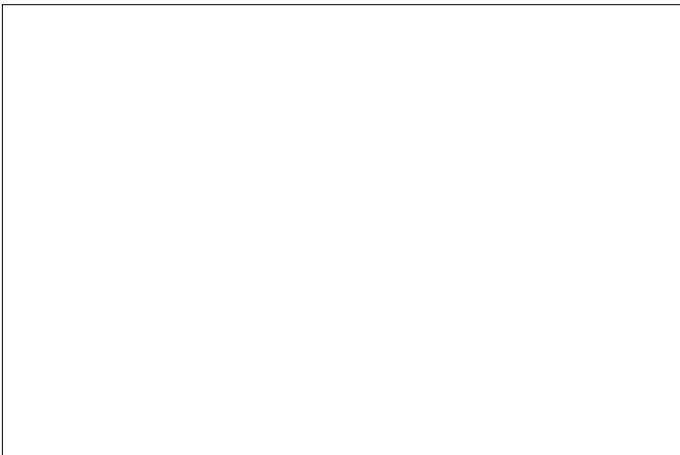

Operating hour display

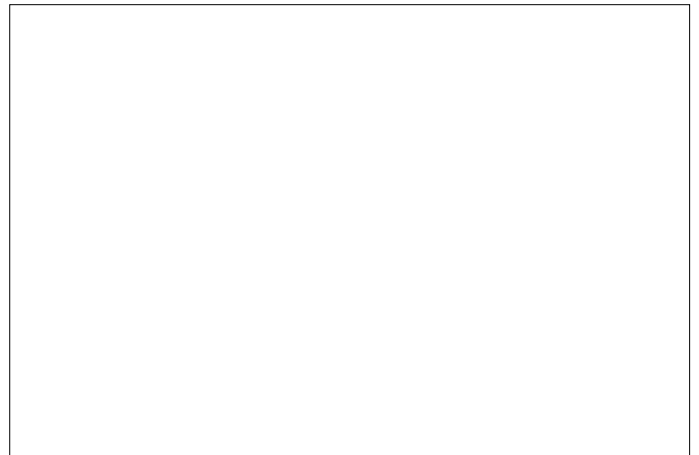

Software version display

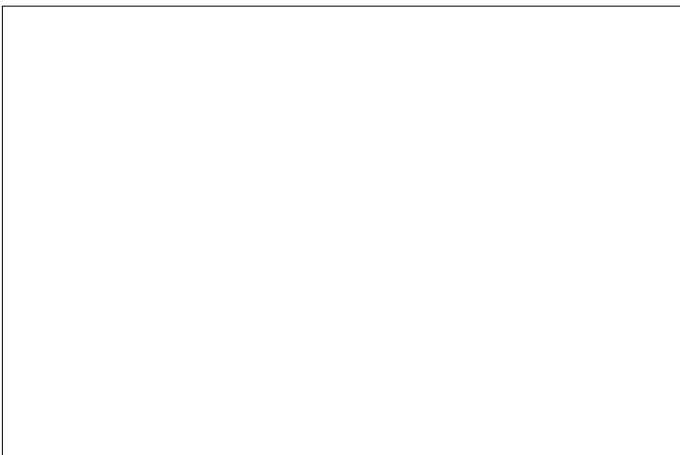

Overview picture of generator drive

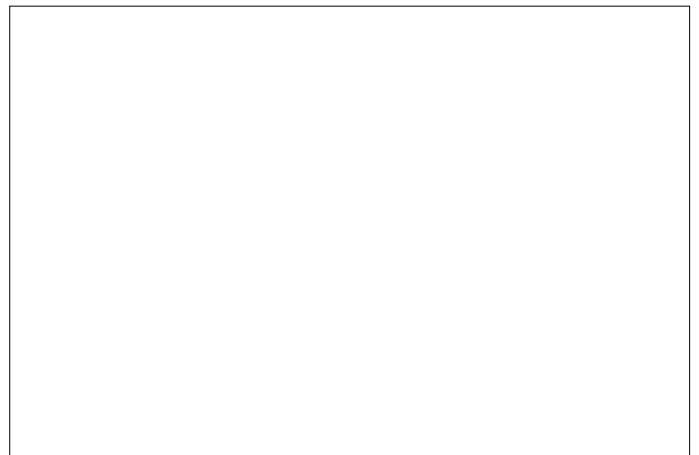

Pictures of damages

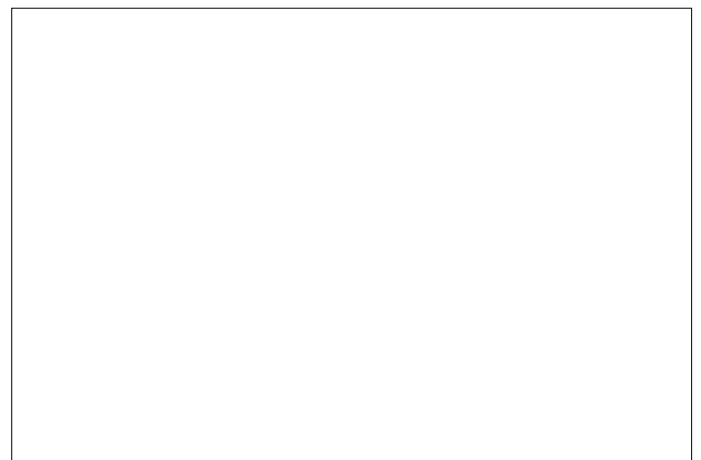
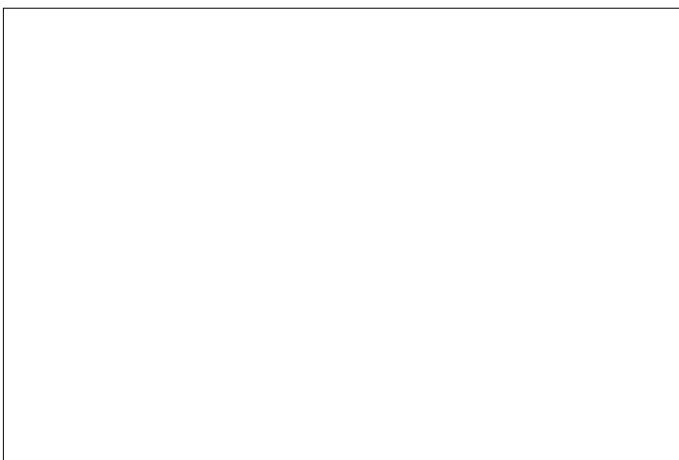
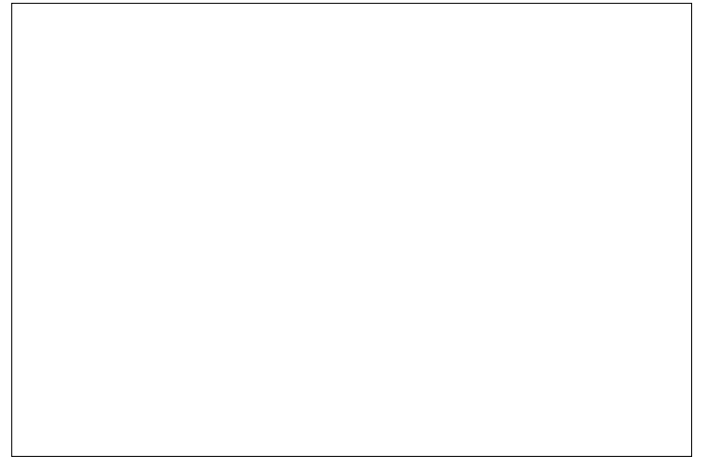
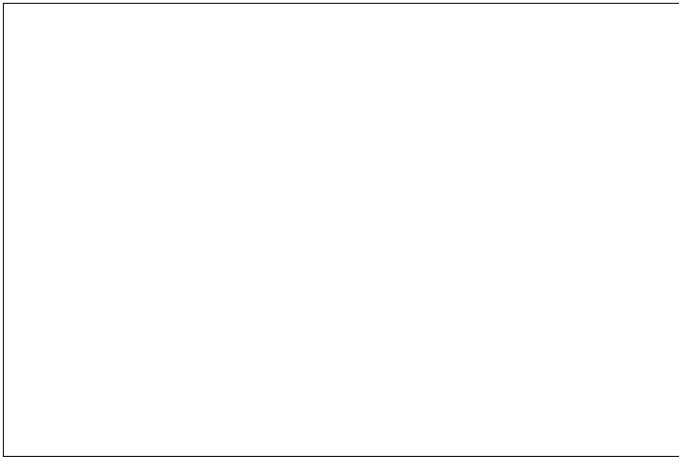

Generator

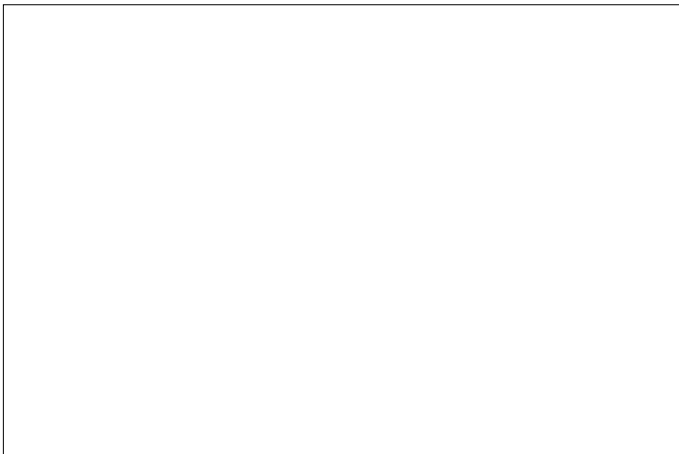

Generator type plate

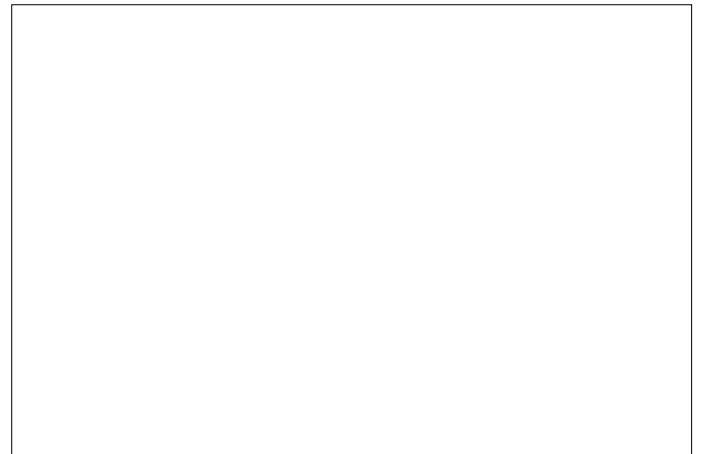

5. Description

The following pages present the installation of generator drive in a wheeled paver. The Installation guide guarantee a technically accurate operating of generator drive with cardan shaft.



If these points are not taken into account, the generator drive can be fail.

5.1 General overview design



5.2 Check anti vibration pads of engine suspension

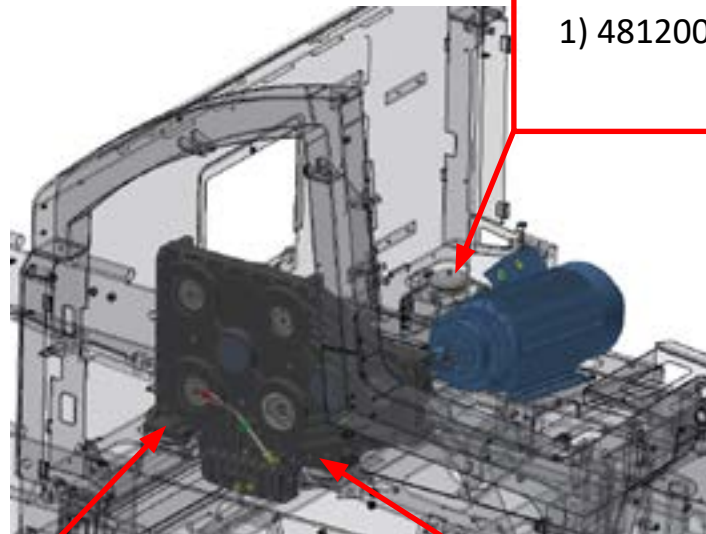

1) 4812009888 Anti vibration pad 45 SH

2) 4812009887 Anti vibration pad 60SH

3) 4812009886 Anti vibration pad 65SH

Measurements



1) Engine

2) Gearbox front

3) Gearbox rear

~36mm

~35mm

~35mm

Notice:

all fluids are filled for drive unit! The setting behavior was considered after 48 hours!

- Hydraulic-oil
- Gearbox-oil
- Engine-oil

 Distance anti vibration pad 1 engine ~36mm

 Distance anti vibration pad 2 gearbox front ~35mm

 Distance anti vibration pad 3 gearbox rear ~35mm

Picture to be added below:

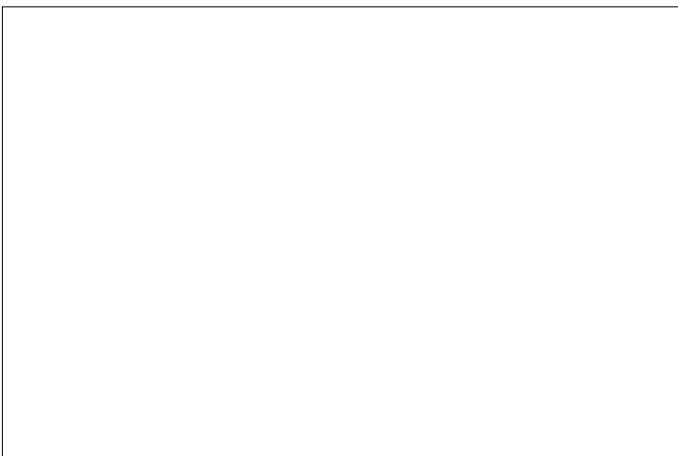

5.3 Fastening of generator coupling

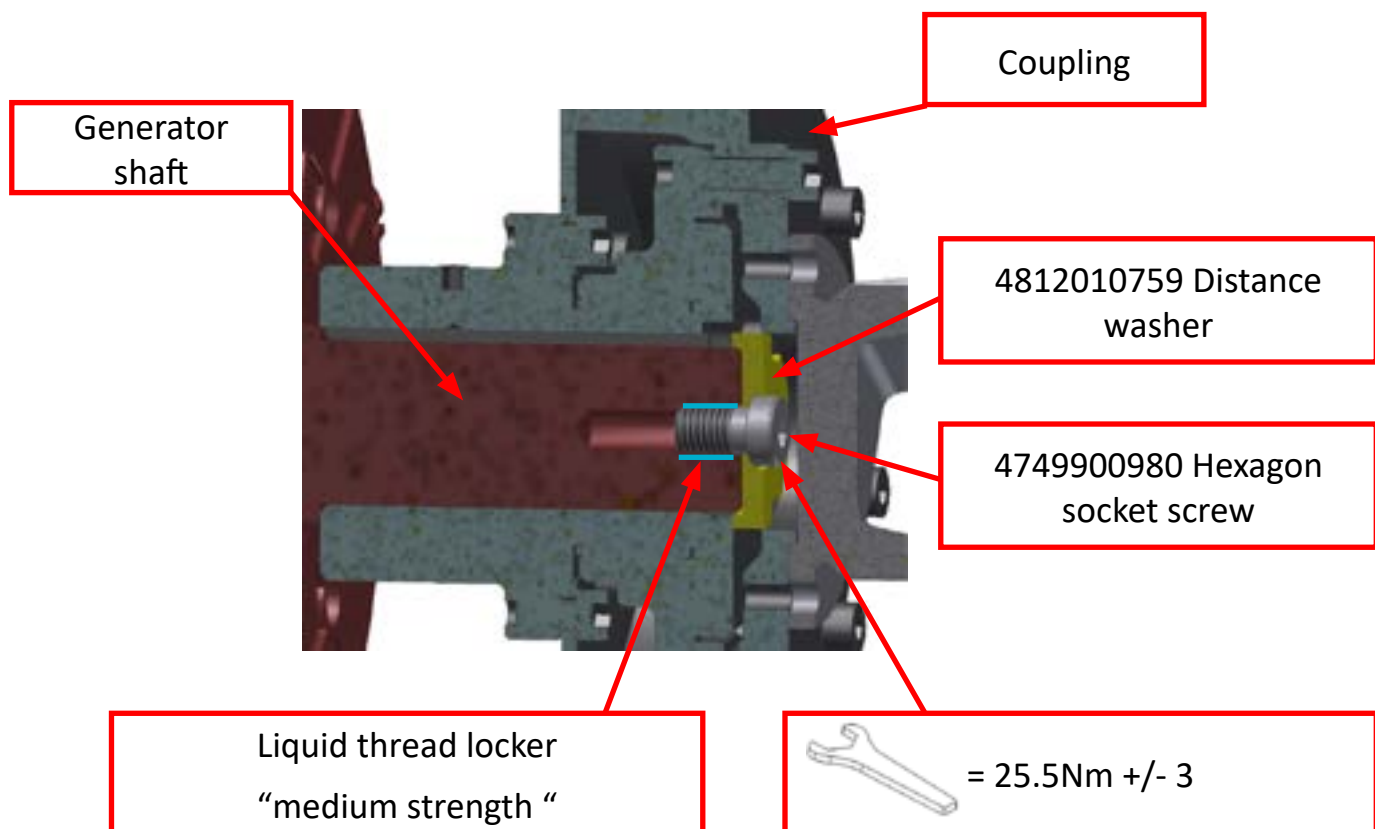

Detailed drawing of distance washer 4812010759

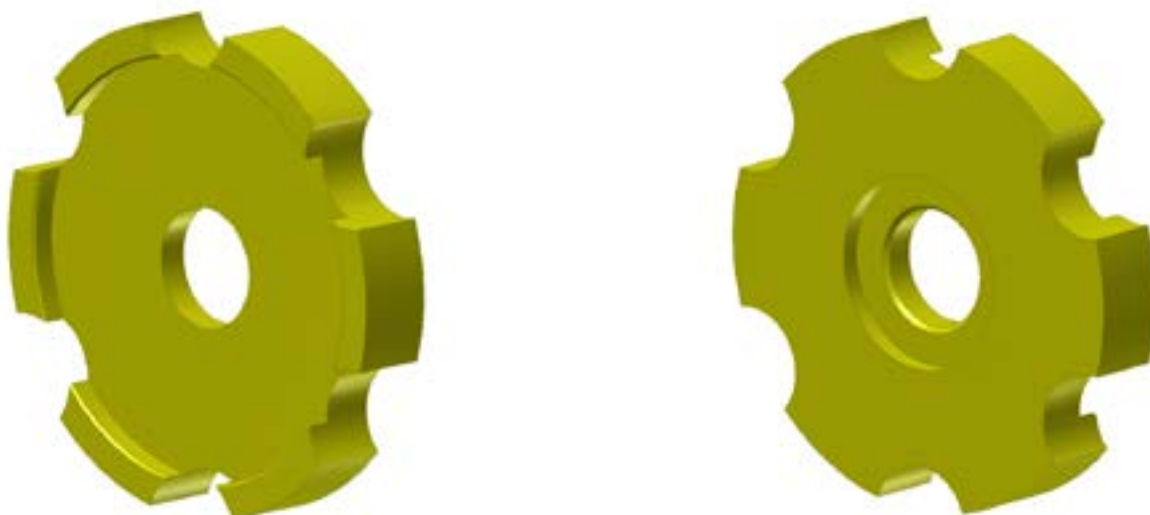

- Surfaces of generator shaft and coupling clean
- Distance washer 4812010759 installed
- Used liquid thread locker “medium strength” for hexagon socket screw 4749900980
- Hexagon socket screw 4749900980 torque 25.5Nm +/- 3

Picture to be added below:

Generator shaft clean

Distance washer installed

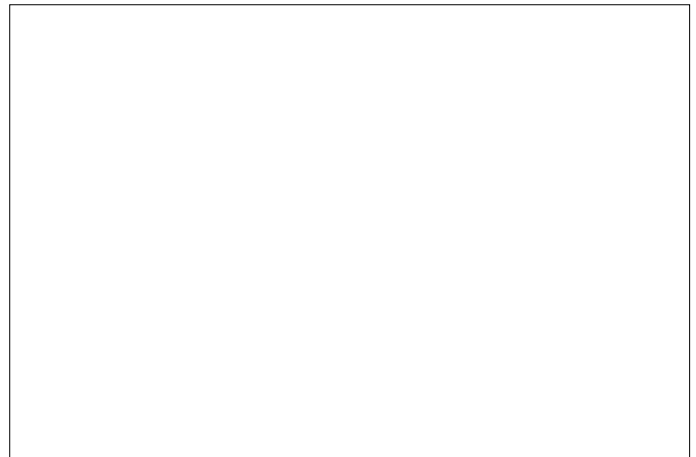
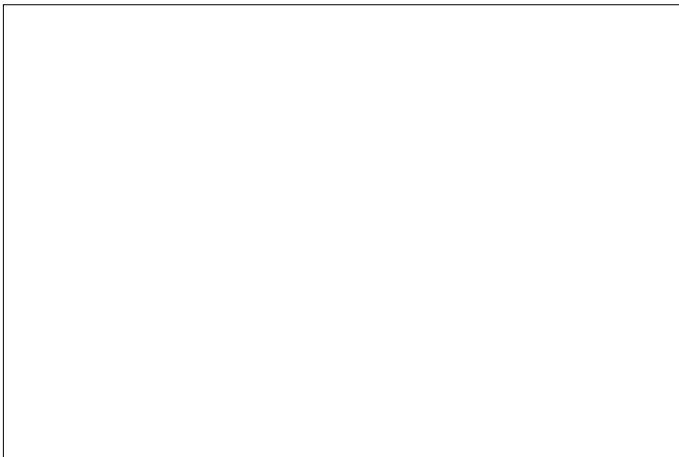

Complete assembly after installing coupling

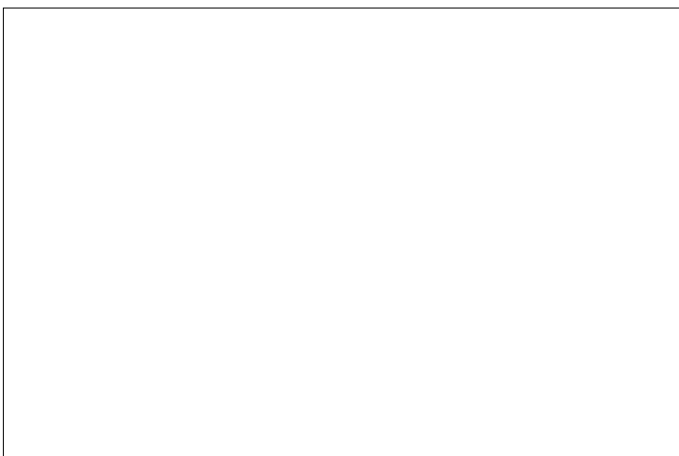

5.4 Design of cardan shaft

The cardan shaft (4812082103) is delivered in balanced condition and ready to install:

Gearbox side: 48mm (drive side)

Generator side: 48mm (output side)

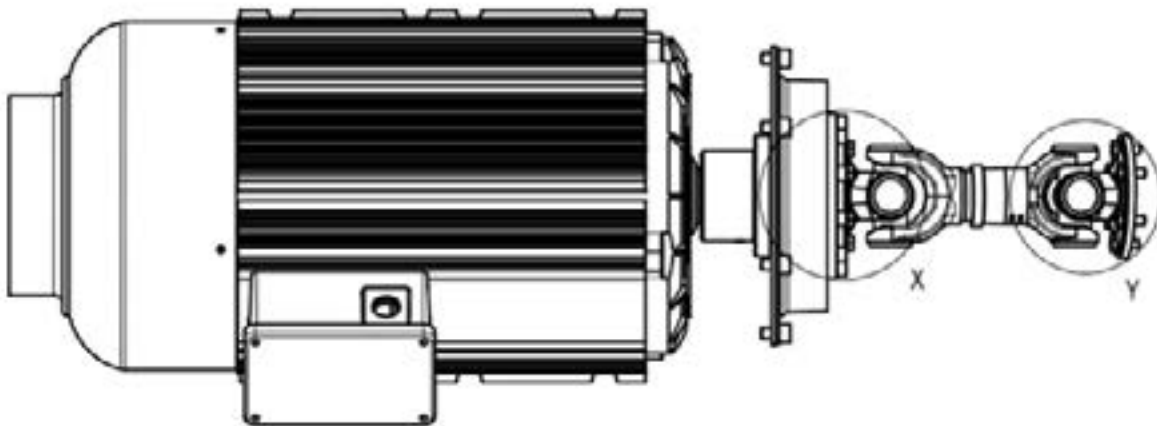

Gearbox

The cardan shafts may not be separated in the spline profile and swapped one for another, as this will severely compromise the balance.

For the same reason, balancing plates may not be removed.



Before installing cardan shafts, it must be ensured that they are assembled properly, i.e. the marker points located on the splined shaft and the splined hub face each other.



Cardan joint distance gearbox side 48mm

Cardan joint distance generator side 48mm

Marker points are inline

Picture to be added below:

Cardan joint distance

Marker points inline

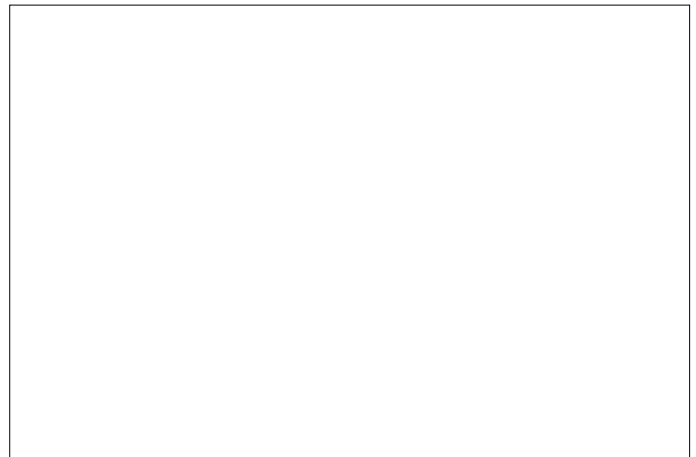
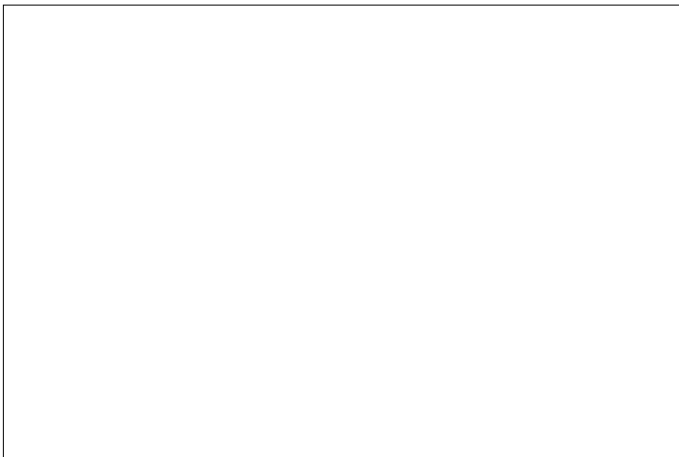

5.5 Bolt connection

The following points of connection for bolts must be observe (**Gearbox and Generator side**):

- The following bolt must be used: 4812217131 – (Quality 10.9 is necessary!!!)
- The specified torque must be observed: 35 Nm
- The indicated thread locker must be used
- The surface of components must be clean, free of grease and dry!
- The cure time of the liquid thread locker has to be considered

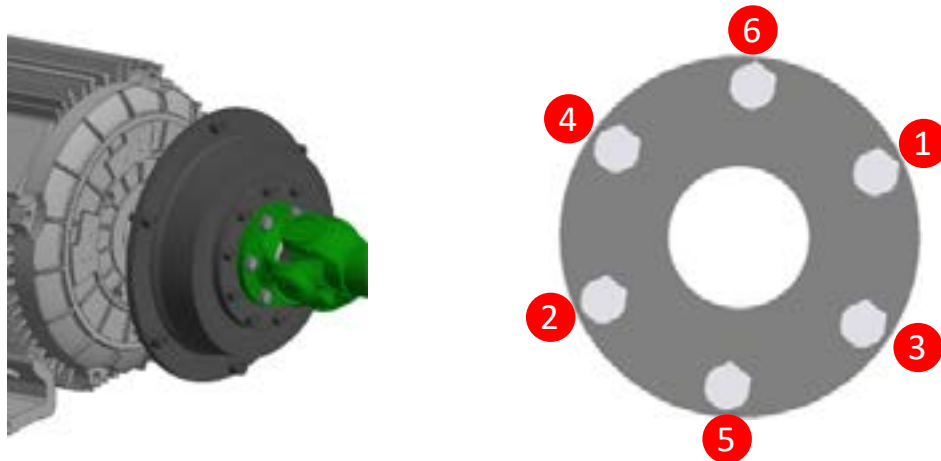

!Only relevant in combination with cardan shaft 4812082103! The adapter ring (4812082244) is a spacer for the bolt connection on both the generator side and gearbox side which guarantees the required clamping length!

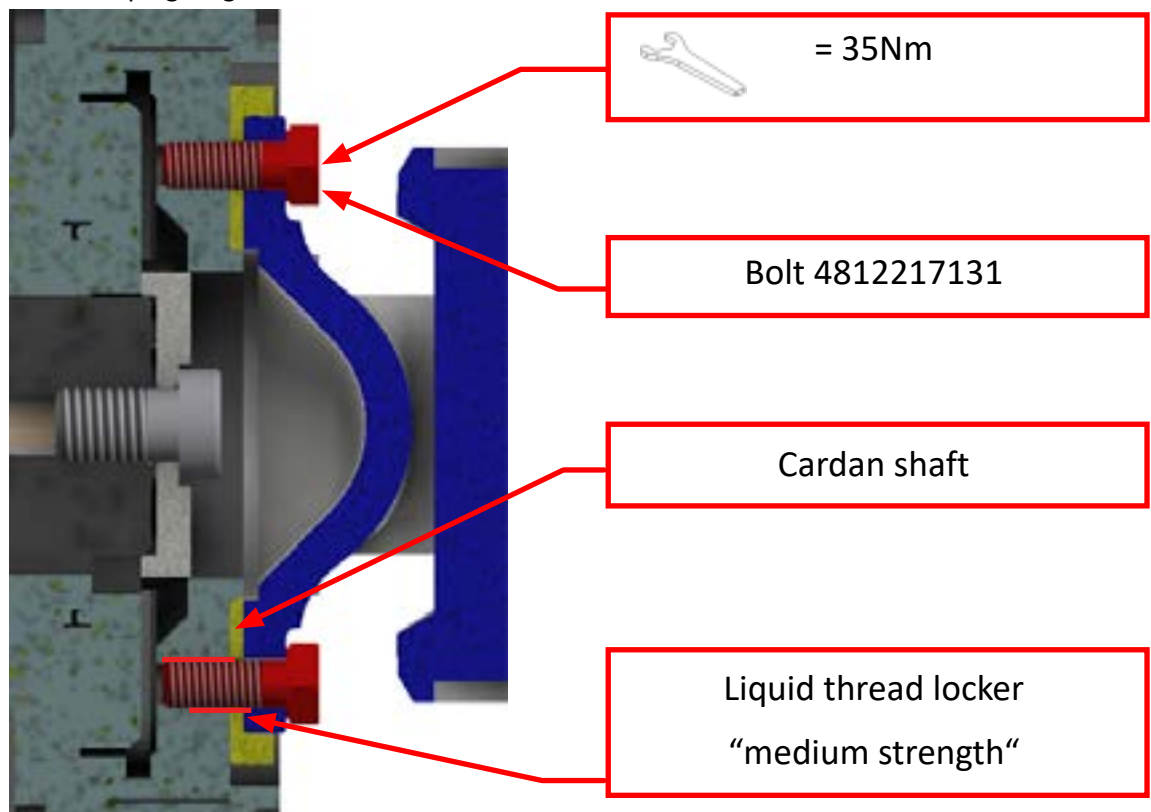

Tighten bolts crosswise

Check descriptions	Generator side	Gearbox side
Bolt 4812217131 used	<input type="checkbox"/>	<input type="checkbox"/>
Indicated threadlocker used	<input type="checkbox"/>	<input type="checkbox"/>
Specified torque 35Nm	<input type="checkbox"/>	<input type="checkbox"/>
Bolts tightened according description	<input type="checkbox"/>	<input type="checkbox"/>
No washers used	<input type="checkbox"/>	<input type="checkbox"/>

Picture to be added below:

Assembly cardanshaft gearbox side

Assembly cardanshaft generator side

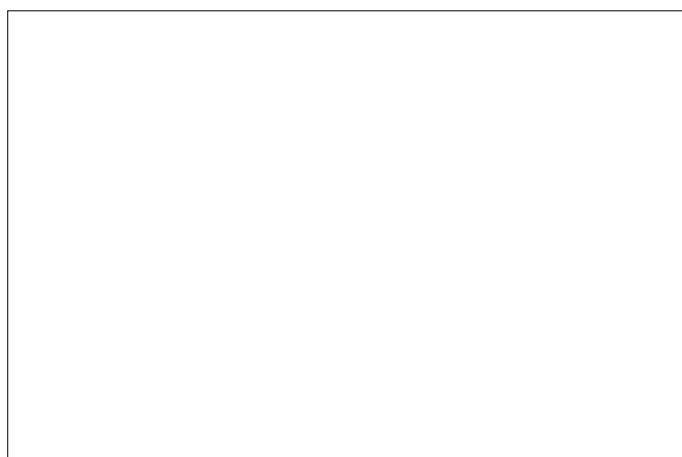
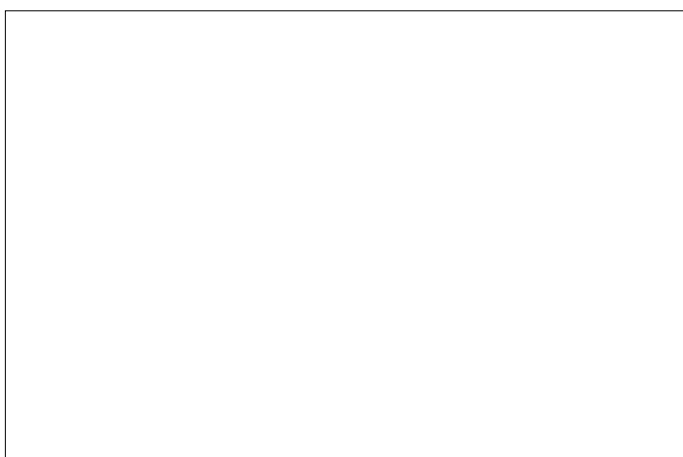

Complete assembly of cardanshaft system

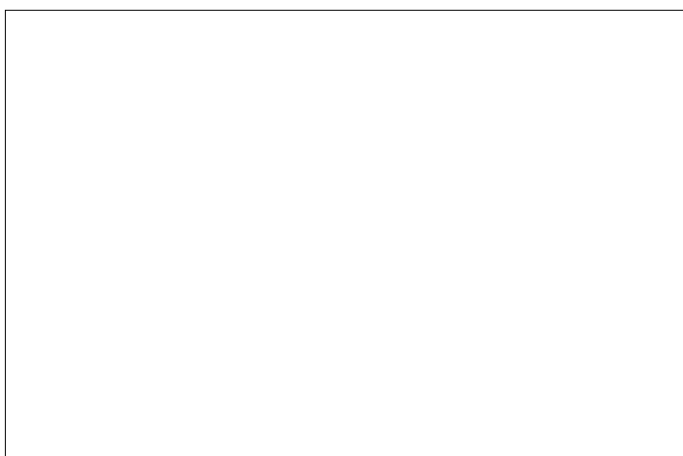

5.6 Dimension of assembled generator drive

Check the dimension of assembled cardan shaft

Notice:

Measuring the assembled cardan shaft:

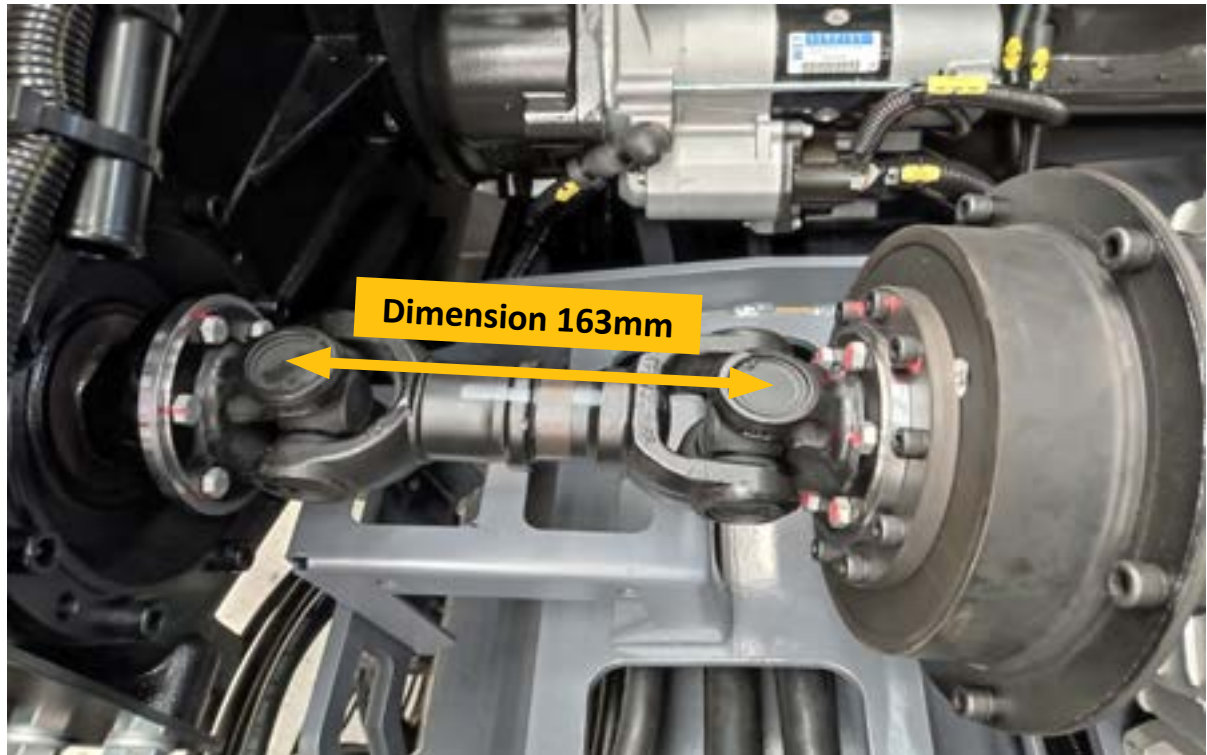

Explanation:

- optimized installation dimension between joints is:
 - Distance: 163 mm
 - distance of joints is:
 - Gearbox side: 46.0 mm
 - Generator side: 46.0 mm
- cpl. 255 mm

 Distance between cardan joints 167.3mm

Picture to be added below:

Cardan joint distance



5.7 Software

The status of software is to check:

- Starting “warm-up ramp at 800rpm” for engine is not include => notice: it’s near by resonant frequency of the drive unit system
- Operating heating speed is 1200rpm (engine speed)
- Engine start without generator load

6. Application

F2500W, F2500WS, SD2500W, SD2500WS with electrical heating (Generation 2016 or higher)

7. Reporting

This workshop instruction with all needed information and pictures needs to send back to the responsible product company:

Machines made in Germany : Click to [Send E-mail gmbh-service@dynamac.com](mailto:gmbh-service@dynamac.com)

Machines made in China : To be clarified with technical support

